

Trade Point Germany GmbH
Am Bahnhof 14
D- 26655 Westerstede

D- Montageanleitung

GB- Assembly instructions

F- Instructions de montage

PL- Instrukcja montażu

RU- Инструкция по монтажу

NL- Montagehandleiding

TR- Montaj talimatı

RO- Instrucțiuni de montaj

IT- Istruzioni per il montaggio

SK- Návod na montáž

CZ- Návod k montáži

HU- Szerelési útmutató

BG- Ръководство за монтаж

P- Instruções de montagem

ES- Instrucciones de montaje

SRB- Uputstvo za montažu

SLO- Navodila za vgradnjo

HR- Upute za montažu

LT- Montavimo instrukcija

LV- Montāžas instrukcija

EST- Montaažijuhend

S- Monteringsanvisning

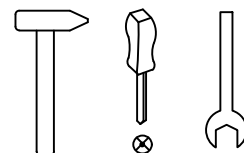
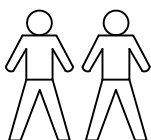

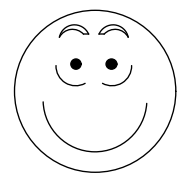
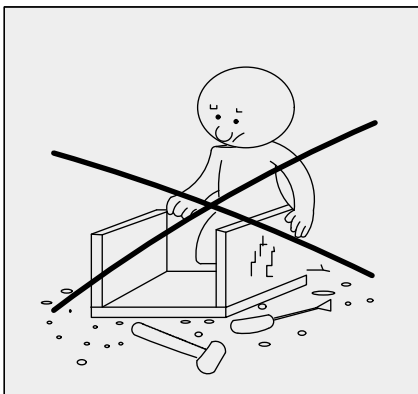
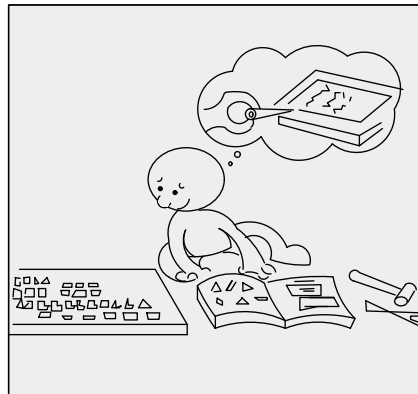
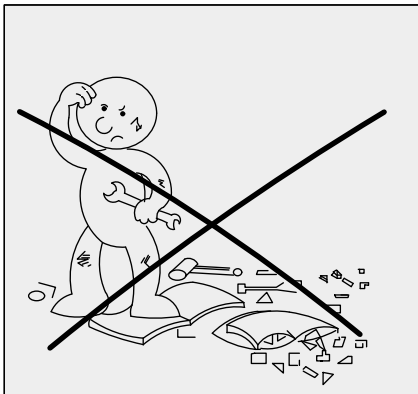
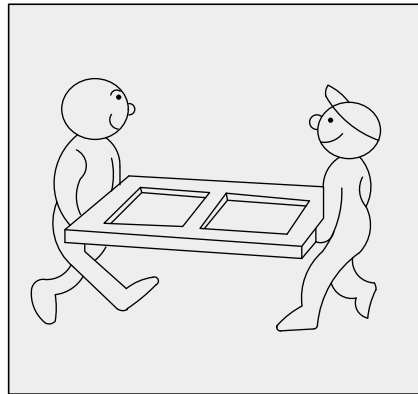
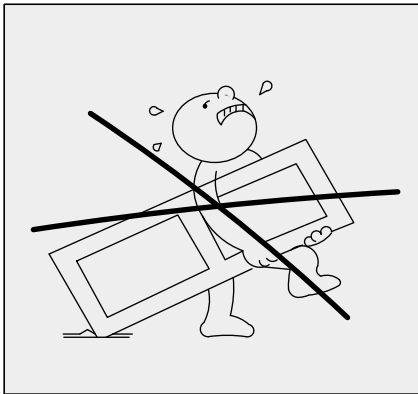
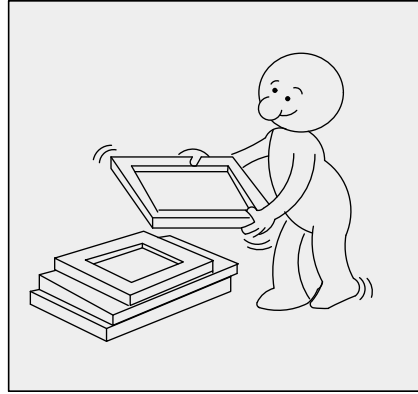
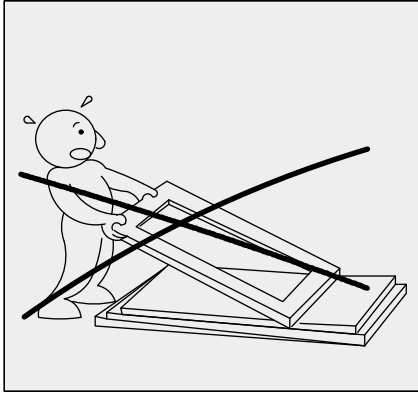
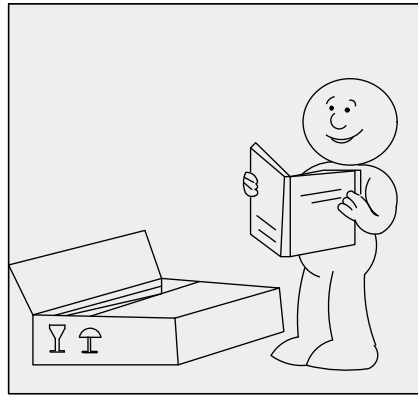
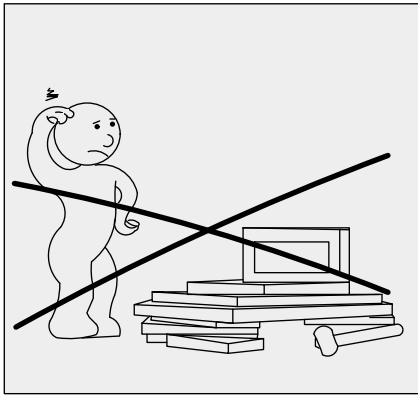

Servicekarte/ Сервизна карта/ Carte service/ Servisní karta/ Service card/ Tarjeta de servicio/
Servisna kartica/ Teeninduskaart/ Szervizlevél/ Servis karti/ Scheda di servizio/ Techninės
prižiūros kortelė/ Servisa karte/ Servicekaart/ Servisna kartica/ Cartão de serviços/ Karta
serwisowa/ Carte de service/ Сервис-карта/ Servicekort/ Servisna kartica/ Servisná karta

IDA TABLE

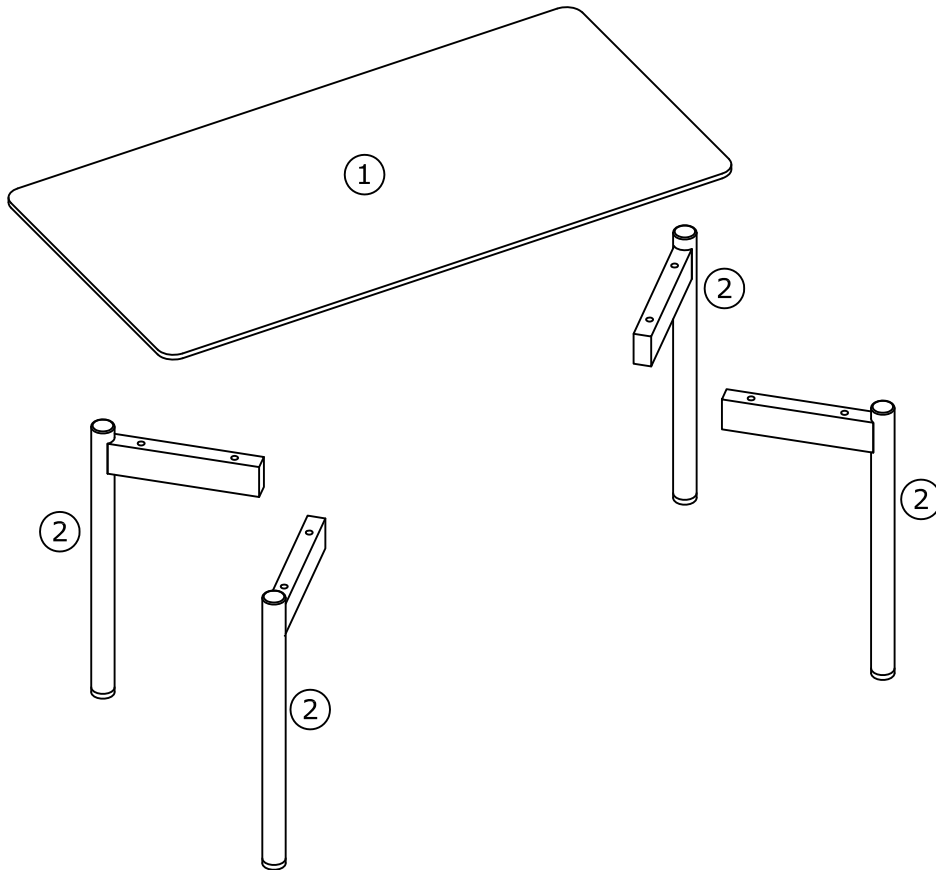

A (8)

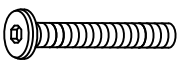

M6x50 mm

B (1)



M4

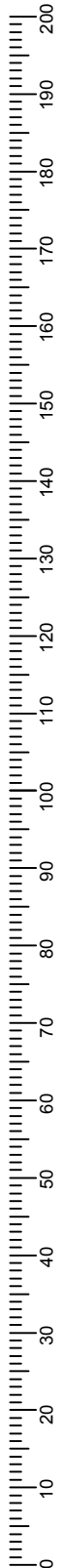

1

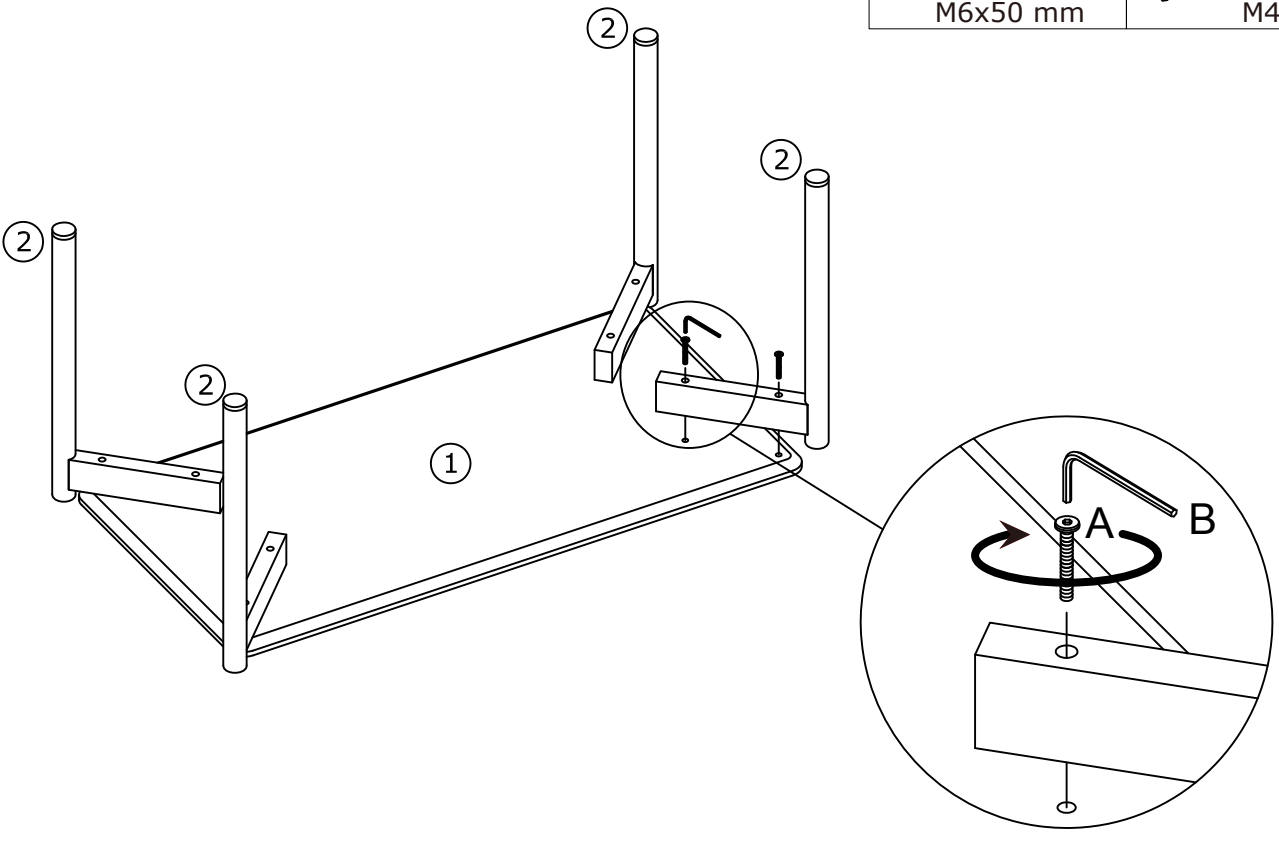
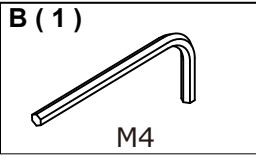
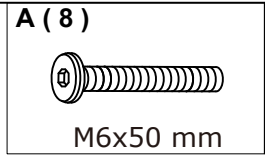

2

