

- |   |                                     |
|---|-------------------------------------|
| <b>(D)</b> Montageanleitung             | <b>(GB)</b> Assembly instructions   |
| <b>(FR)</b> Notice de montage           | <b>(IT)</b> Istruzioni di montaggio |
| <b>(NL)</b> Handleiding voor de montage | <b>(PL)</b> Instrukcja montażu      |
| <b>(CZ)</b> Montážní návod              | <b>(SK)</b> Návod na montáž         |
| <b>(HU)</b> Szerelési útmutató          | <b>(RO)</b> Instrucțiuni de montaj  |
| <b>(TR)</b> Montaj talimatı             | <b>(RU)</b> Инструкция по монтажу   |

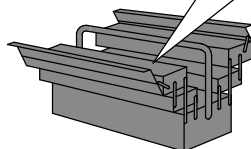
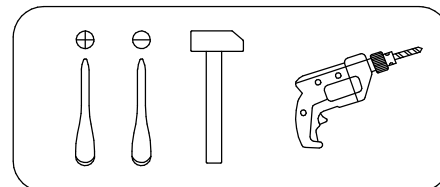
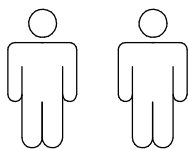

# Service · Dienstverlening · Serwis · Servis · Сервисная служба

Name · Naam · Nazwa · Isim · Название

Nr. · No. · Номер

Typ · Type · Tip · Тип

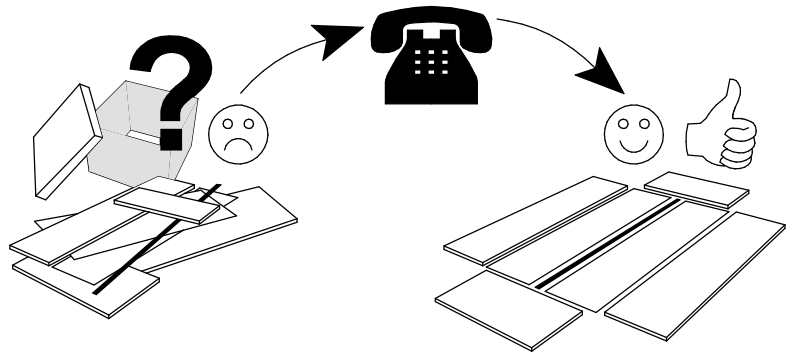
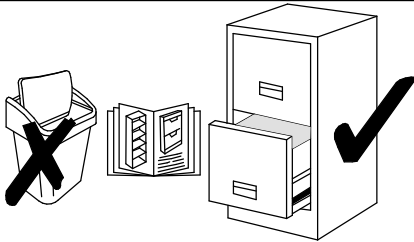

N	Size/MaB (mm)	Qty	✓
1	760×356	1	
2	742×338	1	
3	662×310	1	
4	662×310	1	
5	124×310	1	
6	124×310	1	
7	662×56	2	
8	124×56	2	
9	742×338	1	
10	722×68	1	
11	314×68	1	
12	314×68	1	

N	Size/MaB (mm)	Qty	✓
13	693×304	2	
14	262×50	2	
15	606×120	1	
16	246×94	1	
17	246×94	1	
18	559×94	1	
19	243×568	1	
20	678×355	2	
21	138×712	1	
22	658×302	2	

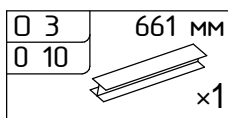
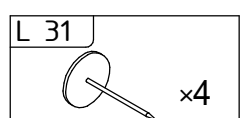
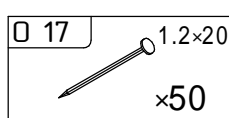
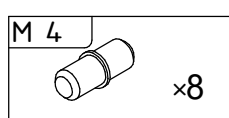
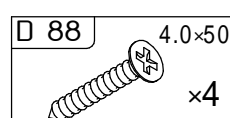
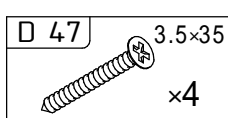
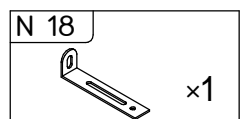
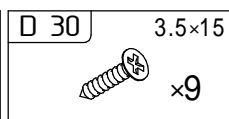
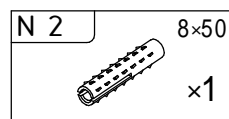
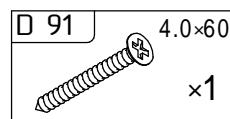
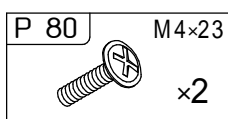
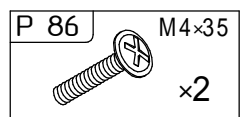
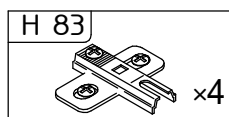
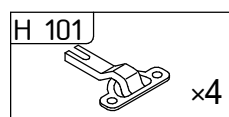
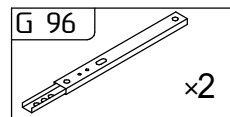
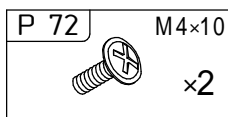
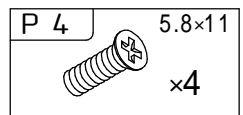
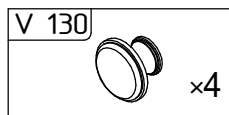
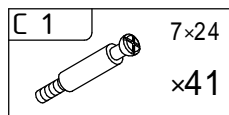
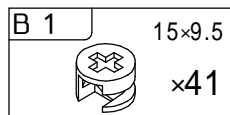
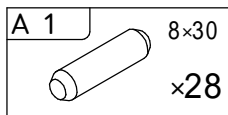

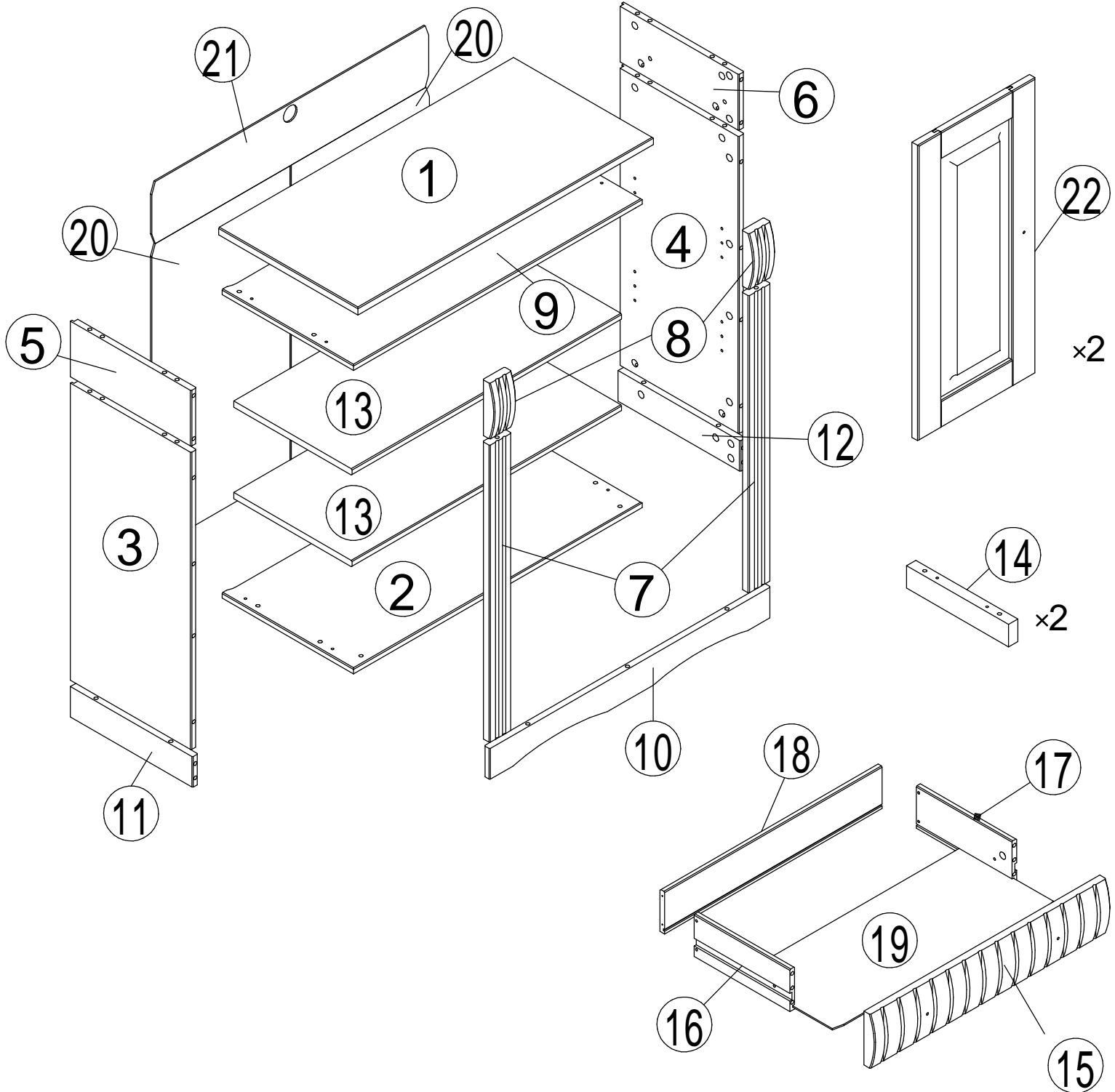
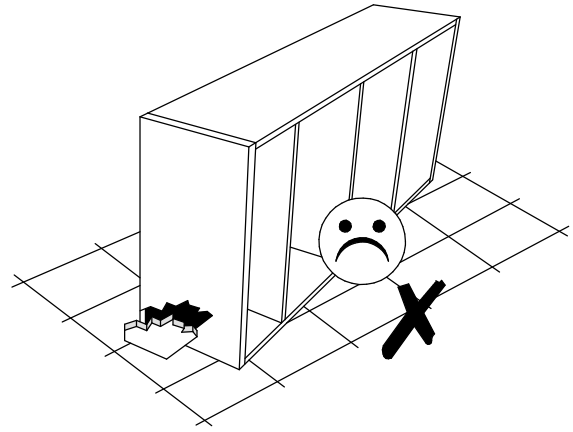
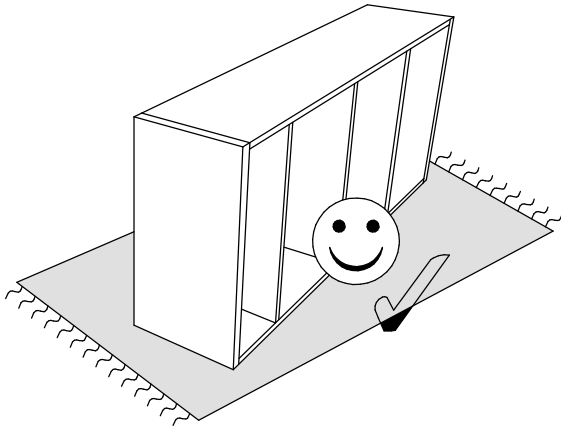

1

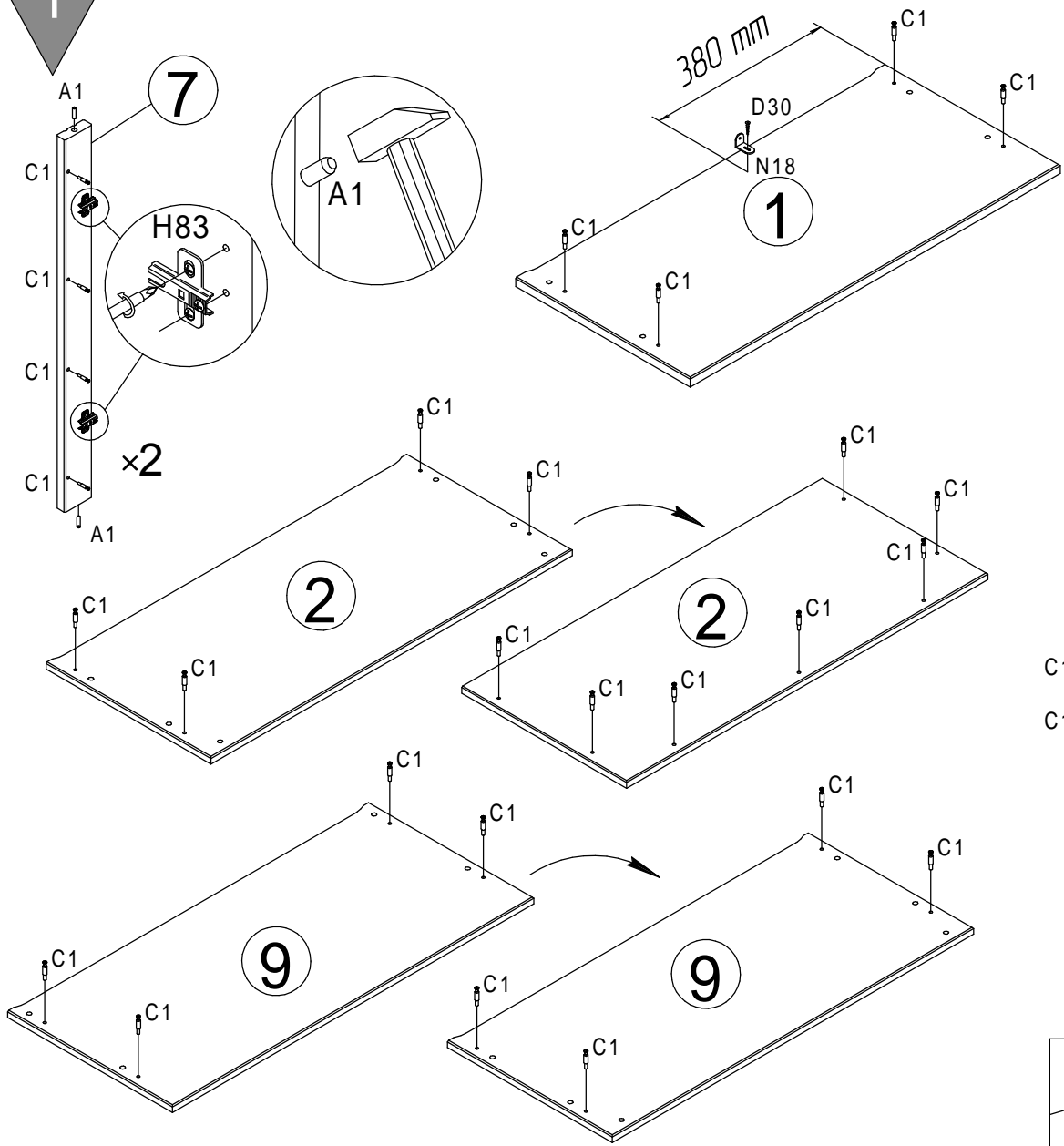

- |      |        |
|------|--------|
| A 1  | 8x30   |
|      | x4     |
| C 1  | 7x24   |
|      | x35    |
| H 83 |        |
|      | x4     |
| D 30 | 3.5x15 |
|      | x1     |
| N 18 |        |
|      | x1     |

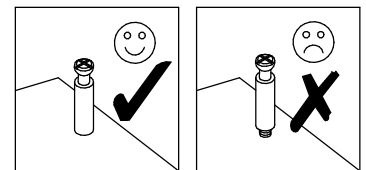
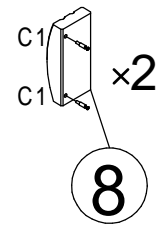

2

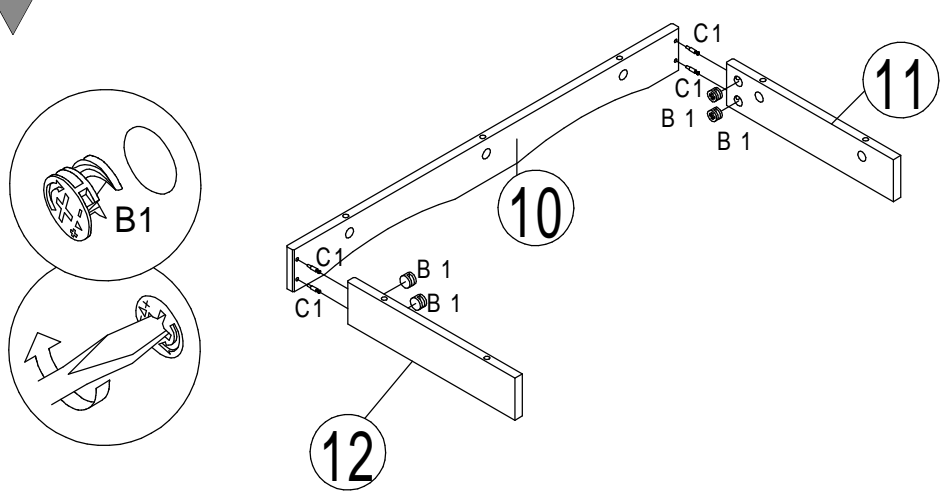

- |     |        |
|-----|--------|
| B 1 | 15x9.5 |
|     | x4     |
| C 1 | 7x24   |
|     | x4     |

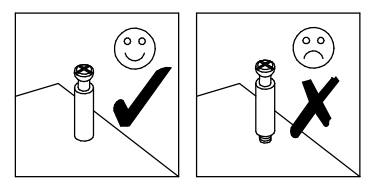

3

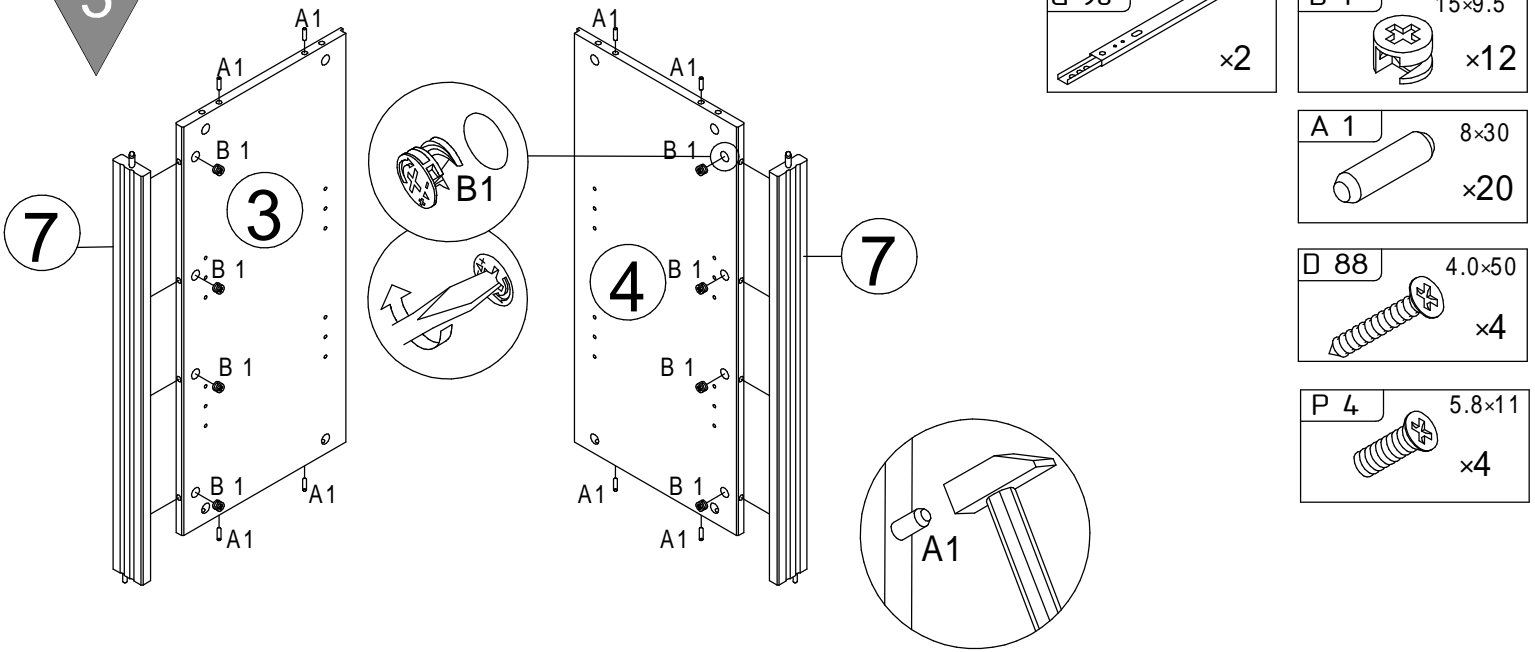

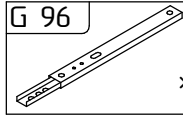
G 96  x2

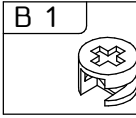
B 1  15x9.5 x12

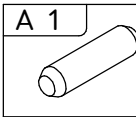
A 1  8x30 x20

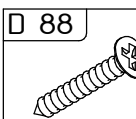
D 88  4.0x50 x4

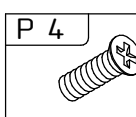
P 4  5.8x11 x4

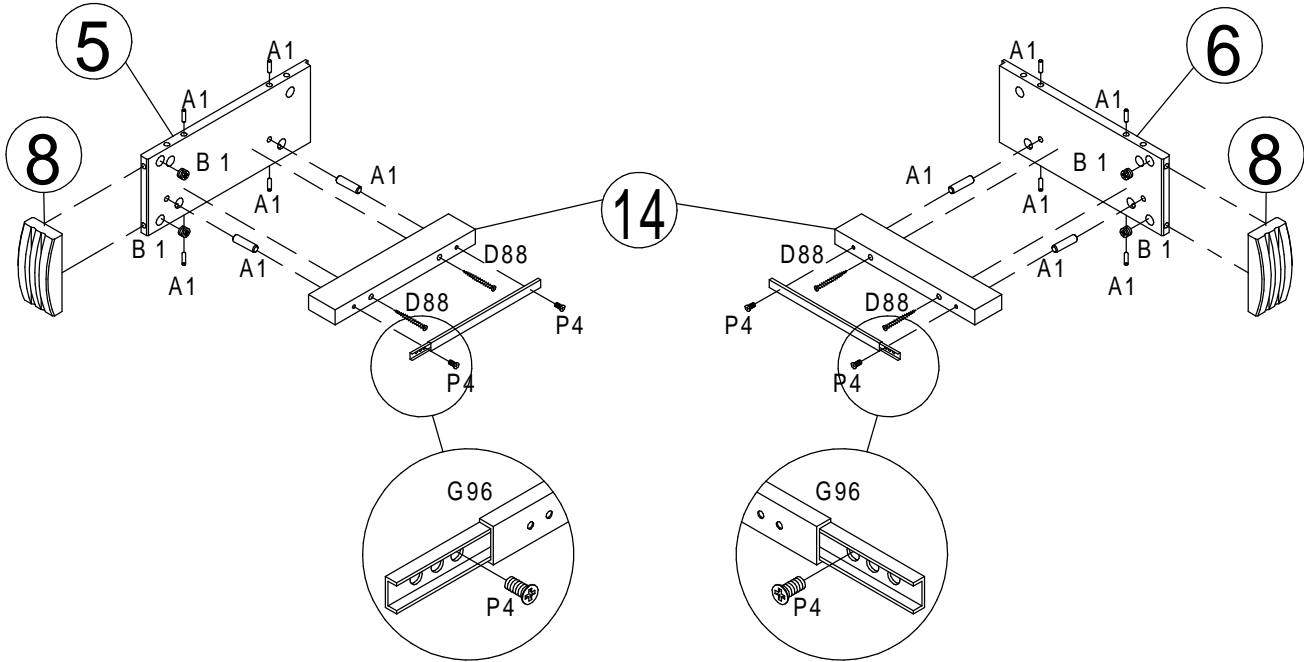

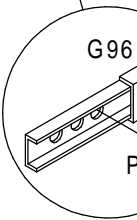
G 96  P 4

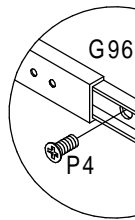
G 96  P 4

4

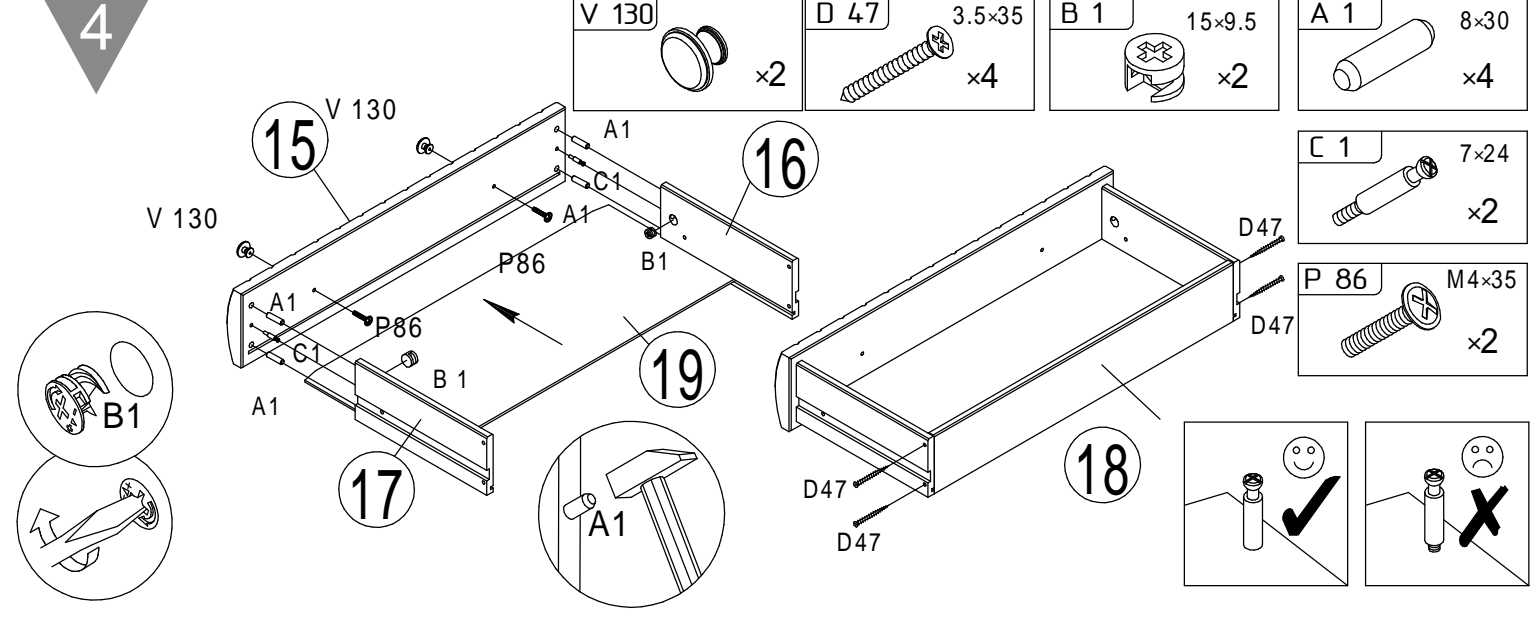

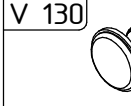
V 130  x2

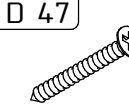
D 47  3.5x35 x4

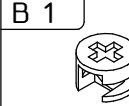
B 1  15x9.5 x2

A 1  8x30 x4

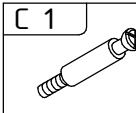
C 1  7x24 x2

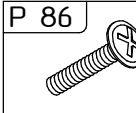
P 86  M4x35 x2

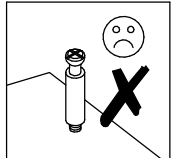
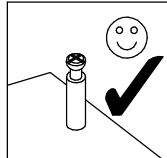

5

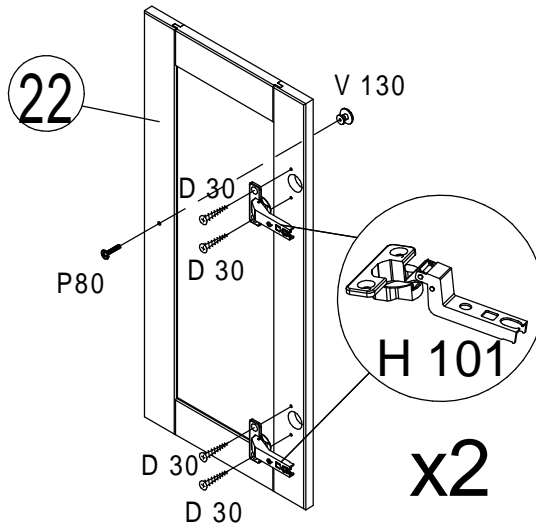

P 80	M4×23
	x2

V 130	
	x2

H 101	
	x4

D 30	3.5×15
	x8

6

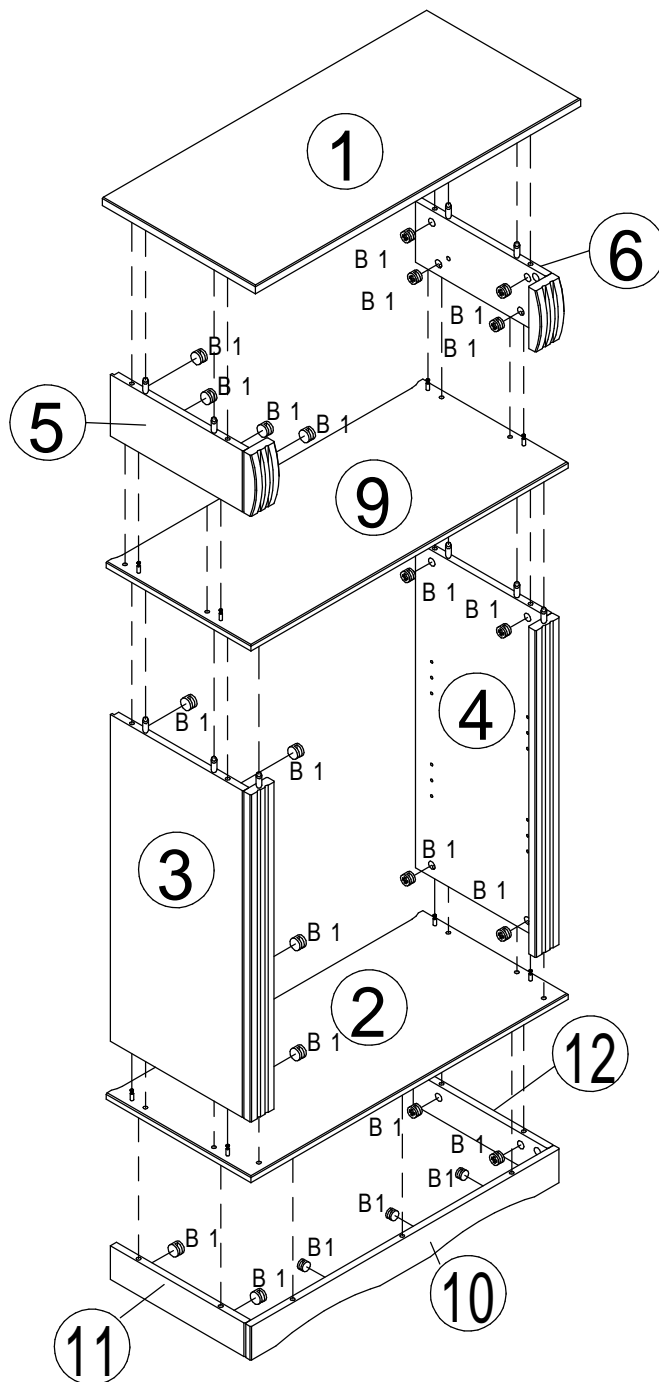

B 1	15×9.5
	x23

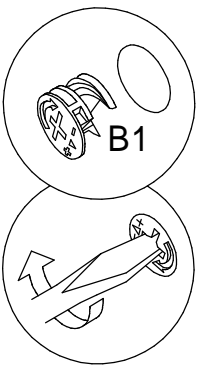

7

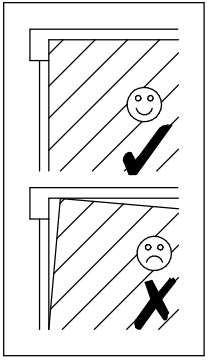
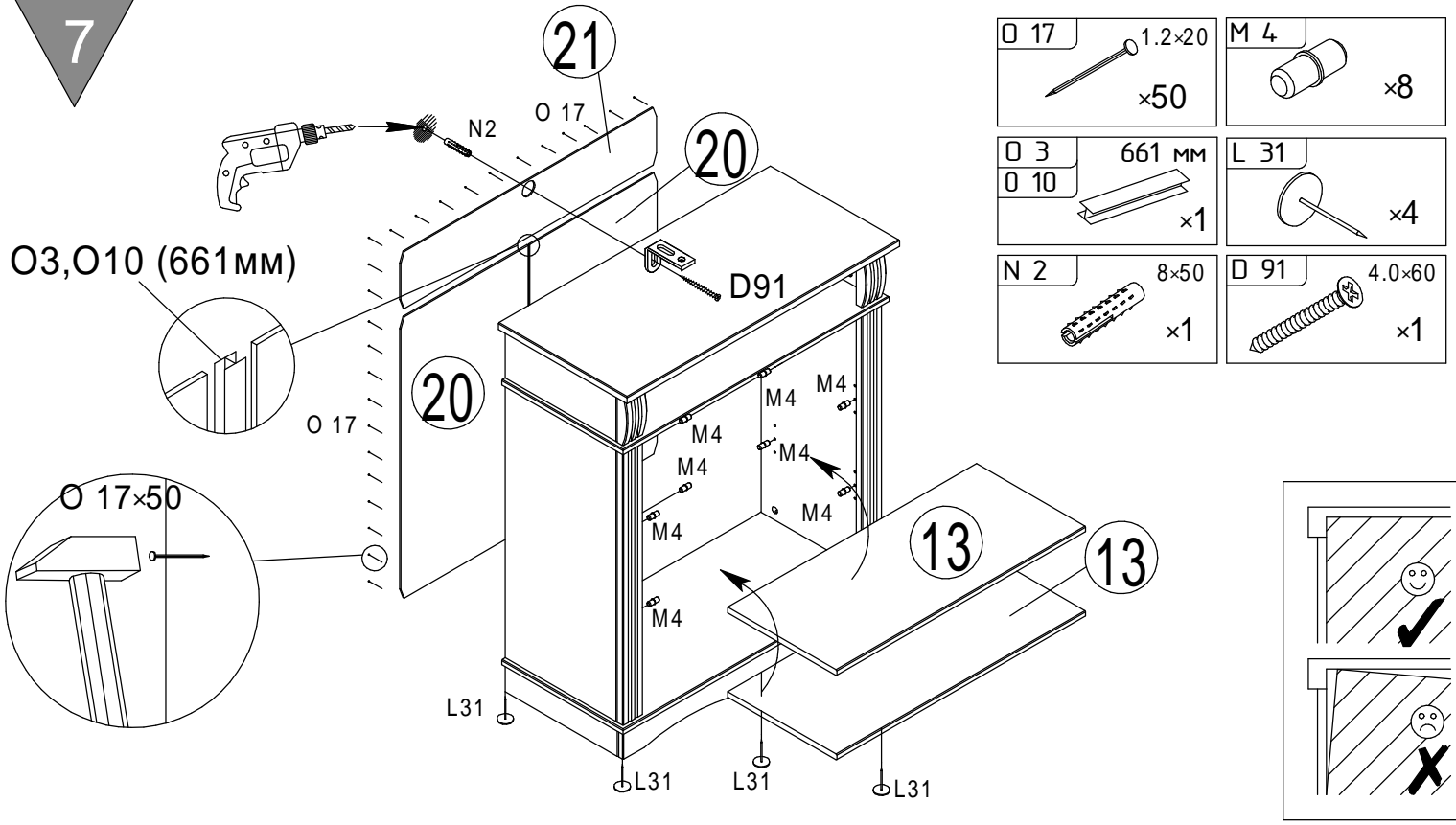

8

P 72	M4x10
	x2

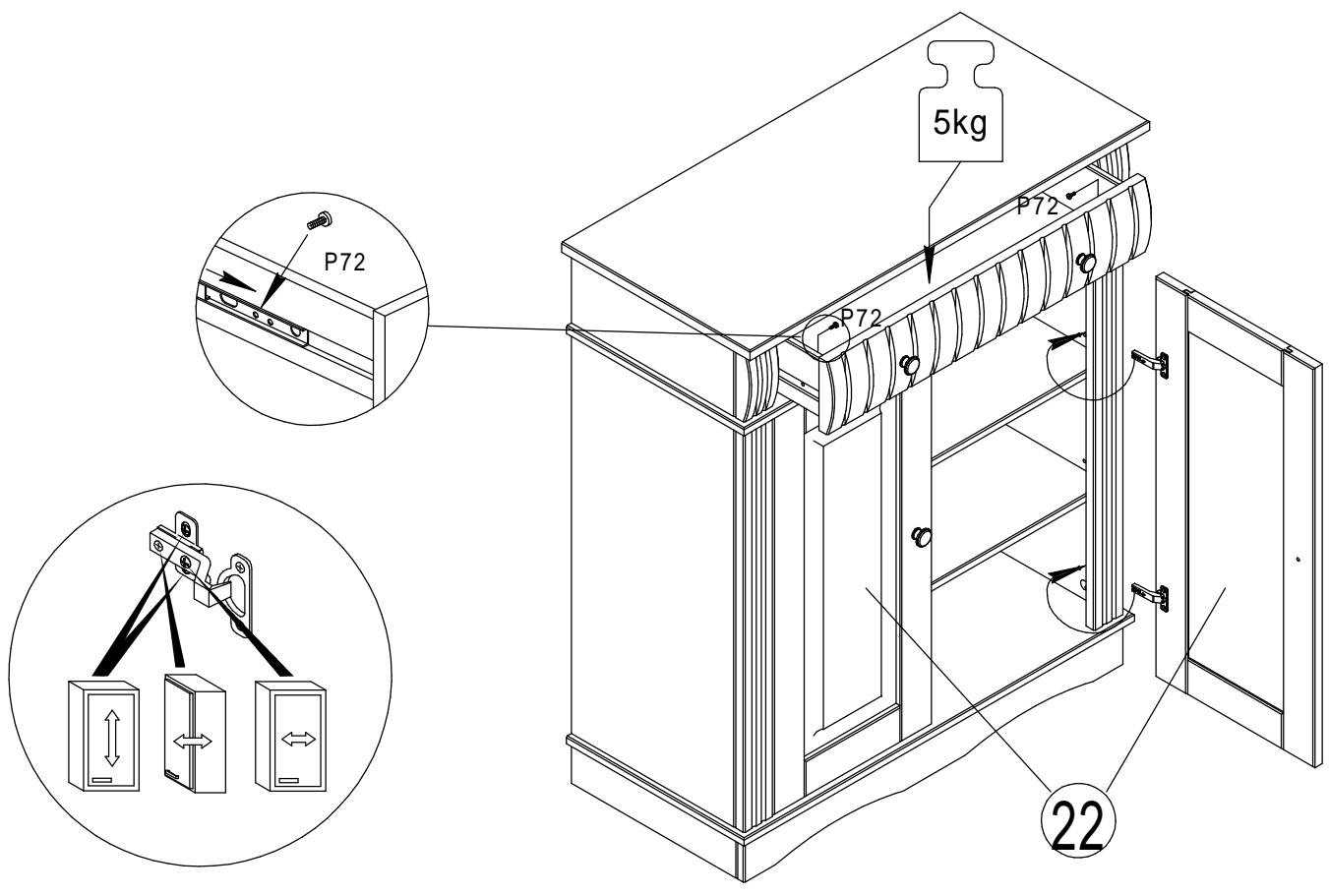



**Achtung • Attention • Attenzione  
Opgelet • Uwaga • Pozor • Figyelem  
Atenție • Dikkat • Внимание**



(D)	Wandbefestigung dient als Kippschutz – unbedingt anbringen! Bei einigen Wandtypen kann ein Spezialdübel erforderlich sein!
(GB)	The wall fastening serves to prevent tipping – be absolutely sure to mount it! For certain wall types, a special wall plug may be necessary!
(FR)	La fixation murale sert de protection contre le basculement – à installer impérativement ! Pour certains types de murs il faut des chevilles spéciales !
(IT)	Il fissaggio alla parete serve da protezione anti-ribaltamento – attaccarla assolutamente! Per alcune strutture di parete può essere necessario un tassello speciale!
(NL)	Bevestiging aan de muur dient als kantelbescherming – zeker en vast bevestigen! Bij enkele muurtypes is een speciale plug misschien vereist!
(PL)	Mocowanie do ściany jest jednocześnie zabezpieczeniem przed przewróceniem – koniecznie zamontować! Do niektórych rodzajów ścian koniecznie zastosować specjalne kołki mocujące.
(CZ)	Montáž na stěnu slouží jako ochrana proti převrhnutí – bezpodmienečně umístěte! U některých typů stěn může být zapotřebí speciální hmoždinka!
(SK)	Upevnenie na stenu slúži ako ochrana proti prevráteniu – bezpodmienečne použite! Pre niektoré druhy stien môže byť potrebná špeciálna hmoždinka!
(HU)	A termékét a falhoz kel rögzíteni, különben az felborulhat! Egyes faltípusoknál speciális tiplit kell használni!
(RO)	Sistemul de fixare la perete servește ca protecție la răsturnare – de montat obligatoriu! Pentru unele tipuri de pereți este posibil să fie necesar un diblu special!
(TR)	Duvardaki sabitleme, devrilmeye karşı bir emniyet tedbiridir ve mutlaka monte edilmelidir! Bazı duvar tiplerinde bunun için özel bir dübel gerekli olabilir!
(RU)	Обязательно установите крепление на стене во избежание опрокидывания! Для некоторых типов стен может потребоваться специальный дюбель!